

AUTOMOTIVE COMPONENTS

Product group	Automotive components
Item number	40451469
Stub length C [mm]	290
Stub length L [mm]	230
Square axle beam [mm]	60
Number of bolt holes	6
Hub diameter [mm].	160
Pitch circle diameter [mm]	205

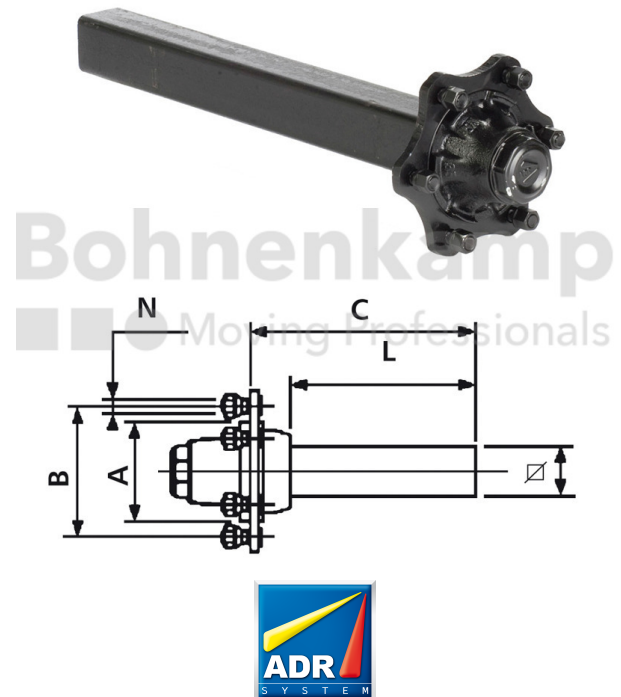

Technical Informations

Brand	ADR
Axle load 40 km/h (single axle) [kg].	2500
Axle load 40 km/h (tandem) [kg]	1750
Axle load 40 km/h (two-axle vehicles) [kg]	2000
ABS	No
Wheel stud type	M18
Thread	M18 x 1,5
Surface treatment	primed
Colour	Black
RAL	RAL9005
Axle beam design	Full material

Axle plates welded on	No
Nettogewicht [kg] (gültig)	16,50
