

AUTOMOTIVE COMPONENTS

Product group	Automotive components
Item number	40451485
Stub length C [mm]	165
Stub length L [mm]	130
Square axle beam [mm]	40
Number of bolt holes	5
Hub diameter [mm].	66
Pitch circle diameter [mm]	112

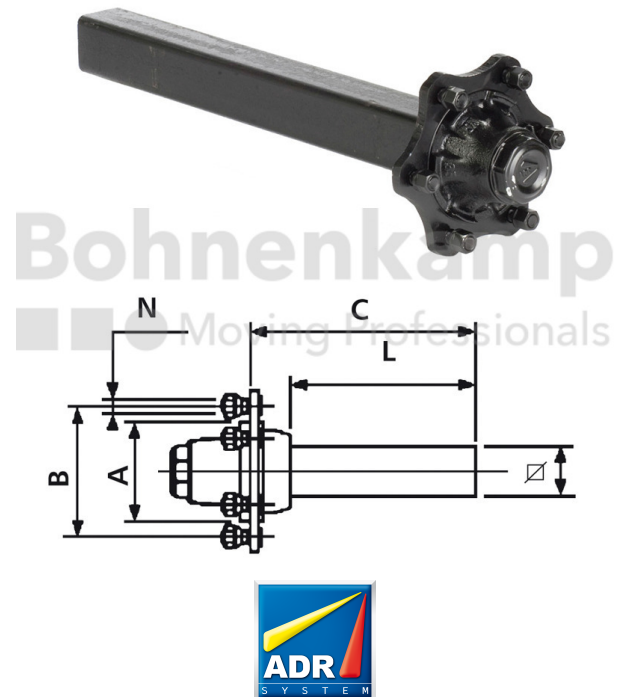

Technical Informations

Brand	ADR
Axle load 40 km/h (single axle) [kg].	975
Axle load 40 km/h (tandem) [kg]	725
Axle load 40 km/h (two-axle vehicles) [kg]	825
ABS	No
Wheel stud type	M14
Thread	M14 x 1,5
Surface treatment	primed
Colour	Black
RAL	RAL9005
Axle beam design	Full material

Axle plates welded on	No
Nettogewicht [kg] (gültig)	5,00
