

## AUTOMOTIVE COMPONENTS

Product group	Automotive components
Item number	40451539
Stub length C [mm]	800
Stub length L [mm]	752
Square axle beam [mm]	70
Number of bolt holes	6
Hub diameter [mm].	160
Pitch circle diameter [mm]	205

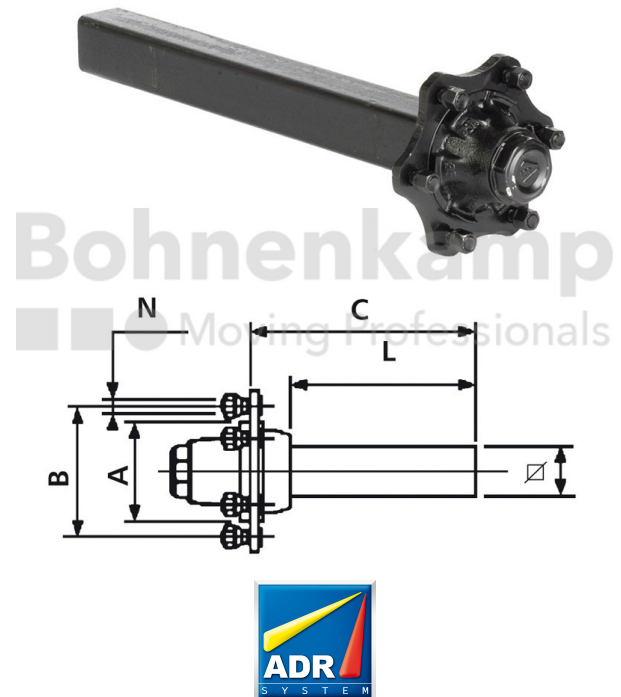

## Technical Informations

Brand	ADR
Axle load 40 km/h (single axle) [kg].	2550
Axle load 40 km/h (tandem) [kg]	2150
Axle load 40 km/h (two-axle vehicles) [kg]	2550
ABS	No
Wheel stud type	M18
Thread	M18 x 1,5
Surface treatment	primed
Colour	Black
RAL	RAL9005
Axle beam design	Full material

---

Axle plates welded on	No
Nettogewicht [kg] (gültig)	33,00

---