

AUTOMOTIVE COMPONENTS

Product group	Automotive components
Item number	40476615
Track width [mm]	1950
Square axle beam [mm]	150
Number of bolt holes	10
Hub diameter [mm].	280
Pitch circle diameter [mm]	335
Brake size	420X180

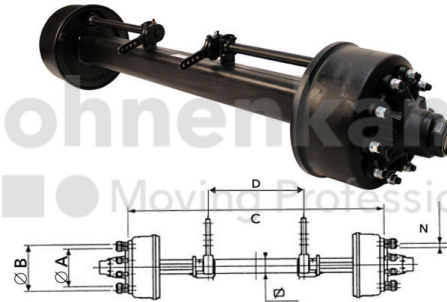

Technical Informations

Brand	ADR
Axle load 40 km/h (single axle) [kg].	14000
Axle load 40 km/h (tandem) [kg]	13000
Axle load 40 km/h (two-axle vehicles) [kg]	14000
Axle load 60 km/h (single axle) [kg].	14000
Axle load 60 km/h (tandem) [kg]	12000
Axle load 60 km/h (two-axle vehicles) [kg].	13000
Type of brake	Pneumatic operated
Brake size	420X180
Brake type	4218E
ABS	No

Version of brake lever	Slack adjuster
Wheel stud type	M22
Thread	M22 x 1,5
Surface treatment	primed
Colour	Black
RAL	RAL9005
Axle beam design	Hollow body
Axle plates welded on	No
Nettogewicht [kg] (gültig)	321,00