

AUTOMOTIVE COMPONENTS

Product group	Automotive components
Item number	42480200

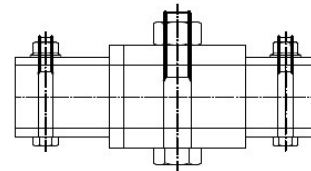
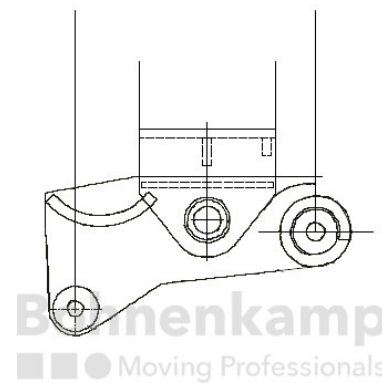

Technical Informations

Brand	Schneider
Brake load compensation	No
Dimension A [mm]	278
Spring bolts	E5
Nettogewicht [kg] (gültig)	14,40